



Wuxi Comput Electronics Co.,Ltd

Mail: Sales@compul.cn Web: www.compul.cn

Tel: 86 510 87359088 Fax: 86 510 87359268

Package Dimensions

CPS04321KL

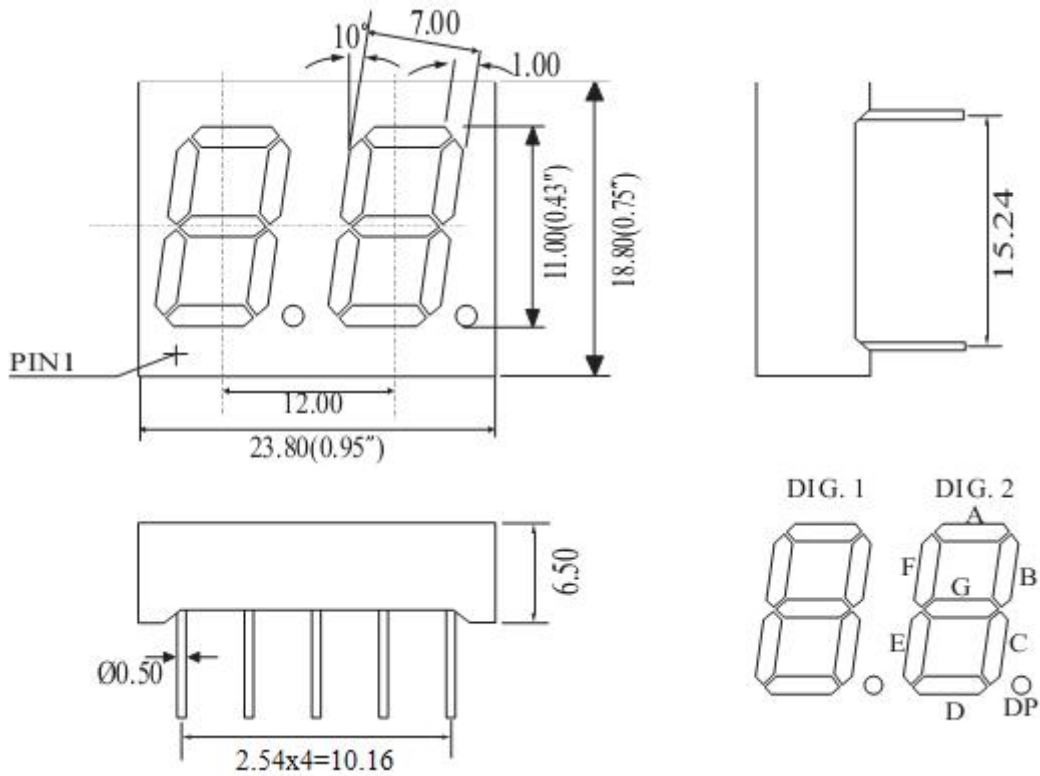

UNIT: MM(INCH) TOLERANCE: ±0.25(0.01")

Internal Circuit Diagram

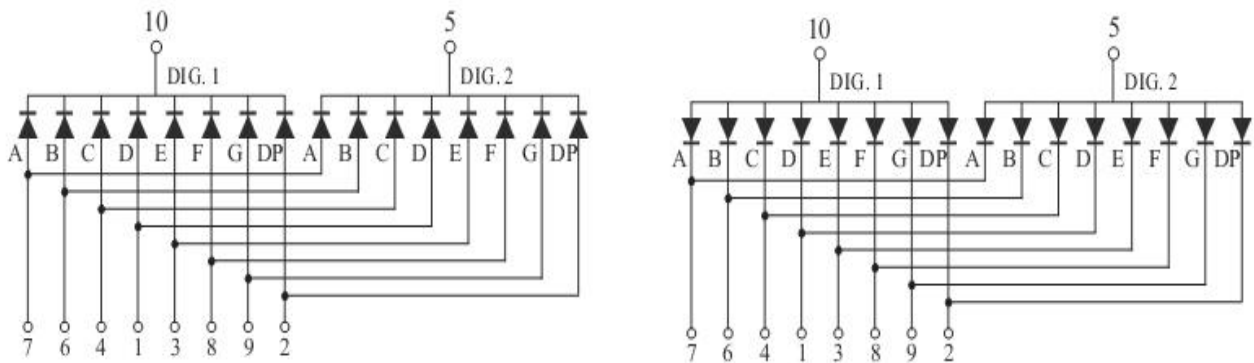

4321K

4321L

Dual Digitals Displays Series